



**Express**  
Elevator Company  
Solution Under One Roof

## PRODUCT RANGE

### ELEVATOR TYPE

- Passenger Manual Door Elevator
- Passenger Automatic Door Elevator
- Panoramic / Capsule Elevator
- Hospital / Stretcher Elevator
- Industrial / Goods Elevator
- Hydraulic Elevator
- Home Elevator
- Machine Room Less Elevator

### RANGE OF DOORS

- Collapsible Manual Door
- Imperforated Manual Door
- Wooden / Steel / Glass Swing Door
- Center Opening Automatic Door
- Telescopic / Sliding Automatic Door
- Steel / Glass Telescopic Door
- Glass Penal Automatic Door

### MACHINE TYPE

- Bottom Traction
- Single Shaft Traction M/C
- Gear Less Permanent Magne



## SERVICE NETWORK

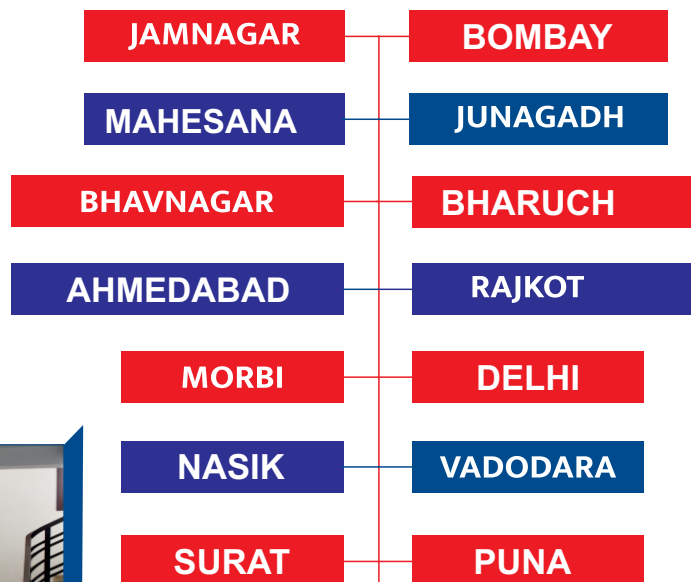

# PANORAMIC CAPSULE LIFT

We provide all types of capsule lifts having ultra modern design to provide a cosmic zone experience to the passengers.

The design provides extremely silent operation. It is also reliable and economical with minimum maintenance.

The VVVF close loop microprocessor controller incorporated with the system makes the whole operation very sophisticated.



Loading Hook Capacity = 3 Ton ( Client Scope)

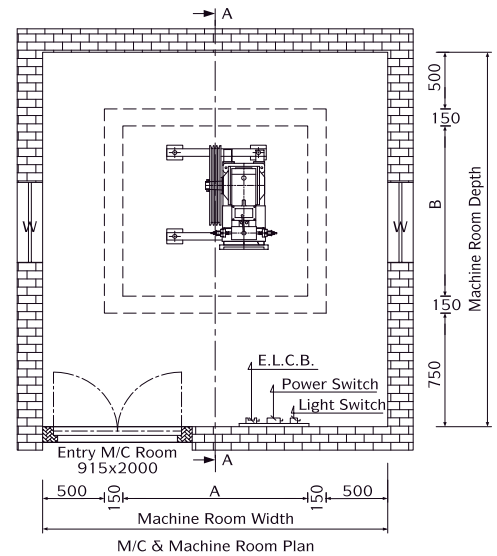
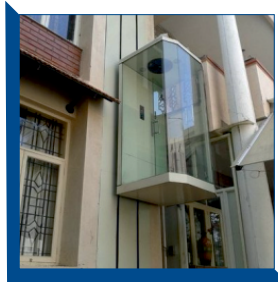
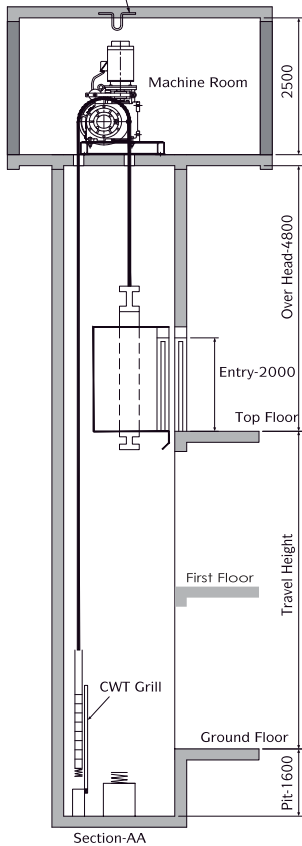

CAPACITY		LIFT WELL		CAR INSIDE		CLEAR ENTRANCE		WALL OPENING		CLEAR OPENING	
Person	Kgs.	D	E	F	A	B	C	H	G	(I) Auto Door	(II) Manual Telescopic
10	680	2250	1050	2400	900	1900	1200	800	1350	880x2100	1600x2350
13	884	2450	1050	2500	900	2000	1400	800	1350	880x2100	1600x2350
16	1088	2450	1250	3000	1000	2500	1400	900	1450	980x2100	1700x2350
20	1360	2450	1500	3400	1200	2900	1800	900	1650	980x2100	1700x2350

# HOSPITAL ELEVATOR

We are manufacturing stretcher elevators of various capacities & speeds to suit customer's requirement.

The Cabin we provide for patients, are spacious & very comfortable with proper exhaust system and jerk free stopping.

It is also designed to transport bulky hospital equipment. Versatile automatic control system is provided to permit economical self-service or an attendant. Emergency control system makes the lift reliable and safe.

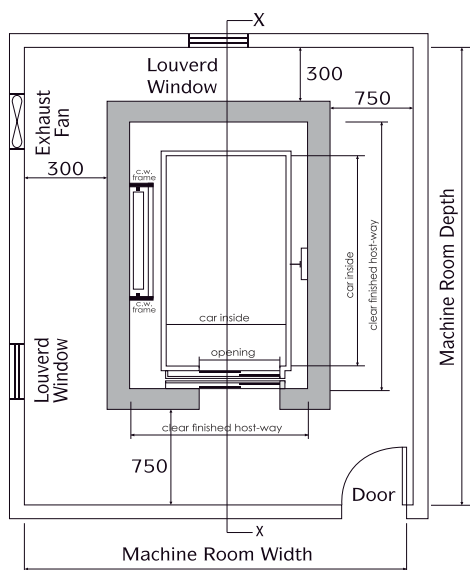

## HOSPITAL ELEVATOR

LOAD		LIFT WELL		CAR INSIDE		ENT.	MACHINE ROOM			UP TO 0.7 M/Sec	
Person	Weight	Width	Depth	Width	Depth		Width	Depth	Height	PIT	O.H
	In Kg.	C	D	A	B	E	F	G	H	K	M
15	1020	1700	3000	950	2400	800	3800	4000	2500	1600	4800
20	1360	2200	3000	1300	2400	1200	4500	4500	2500	1600	4800
26	1768	2350	3000	1600	2400	1200	4800	4800	2500	1600	4800



# FREIGHT ELEVATOR

We provide a complete range of freight elevators of different load carrying capacity. An EXPRESS freight elevator in your building will make handling of goods easy & enhancing production. We supply freight elevators with dust proof equipments as per our customers with dust proof equipments as per our customer's requirement.

Directly and indirectly, modern freight elevators make for efficient operation throughout the building.

The results of properly planned freight elevator installation show up in increased material handled volume and greater earning power.

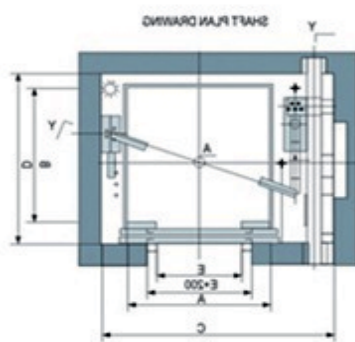
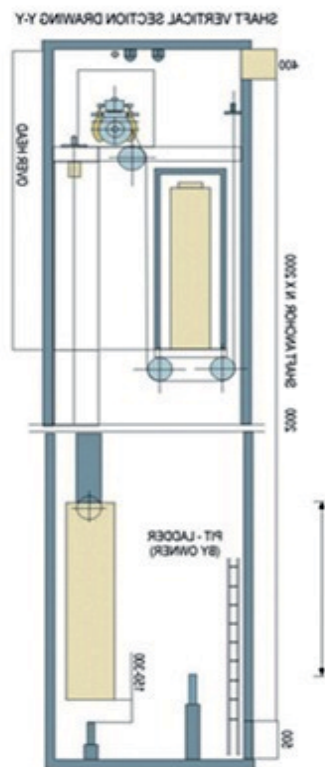

## Elevators for light four wheelers - capacity - up to 2500 kg

### Note :

Overhead requirement minimum 4800mm in all type of lift. Vertical sliding doors can be provided where floor height is 4000mm or more and overhead is 4200mm minimum. Collapsible, Swing double doors can be provided at landing as per requirement. For further details, Please contact our sales representative.

# HOME ELEVATOR

## ■ PMSM Gerless Machines for Home Elevators

- The new Greenstar mini simplifies vertical mobility inside your home.
- Travel comfortably to every floor.
- Give elderly and dependent people the freedom to move from floor to floor without using the stairs.
- Greenstar Mini is a Gearless PMSM machine, ideal for loads up to 300 kg and travel up to 15 meters.
- Greenstar Mini is compact and facilitates elevators with a minimum of space and civil work.
- Greenstar Mini operates on single-phase 230V domestic power supply.
- Greenstar Mini is silent, it uses no oil, reduces power consumption and is also eco-friendly.
- Unique design and layout, permit entrances from three sides.

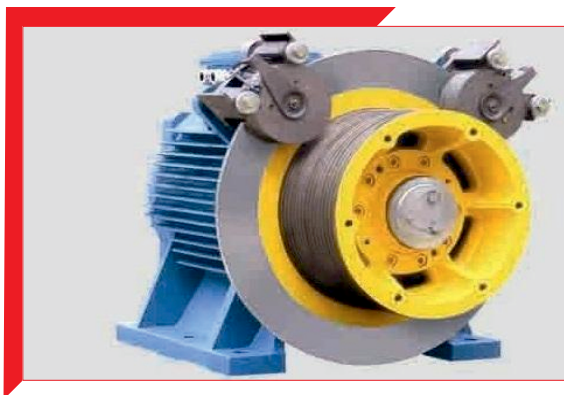

**Gearless With PMS Motor**



## DIMENSIONS TABLE

DOOR OPERATION	LOAD		LIFT WELL		CAR INSIDE		ENTRANCE	SPEED	PIT	OVER HEAD
	Person	Kgs.	C	D	A	B				
MANUAL DOOR	3	204	1100	1200	810	700	700	0.3	550	3100
MANUAL DOOR	4	272	1300	1400	800	1200	700	0.3	550	3100
AUTO DOOR	3	204	1250	1250	810	700	700	0.3	550	3100
AUTO DOOR	4	272	1300	1600	850	700	700	0.3	550	3100

# HYDRAULIC ELEVATOR

## Hydraulic Principle

On impact, the downward motion of the plunger assembly displaces oil through the metering tube holes, thereby decelerating the impacting mass. The buffers's performance characteristics are dependent upon the size and distribution of these holes.

The re-extension of the plunger after impact is effected by a unique gas spring. This gas spring contains nitrogen at a pressure of 20 to 30 bar. The area differential between the top and bottom of the piston results in net force which re-extends the plunger after the compressive load is removed; (the gas is not compressed).

Thus the buffer performance on impact relies solely on oil displacement. The gas spring serves only to re-extend the plunger. Moreover, frictional force of the plunger remains re-extended.

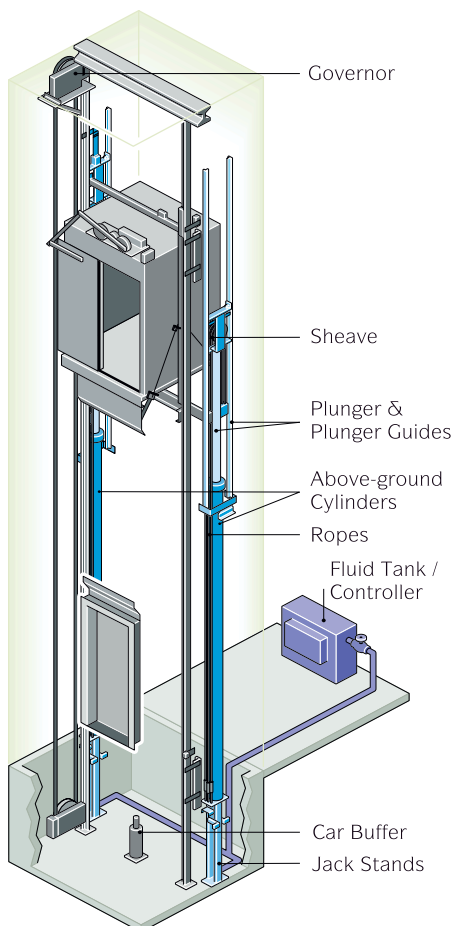

## VARIOUS OPTIONS

- Push button
- Soft Starter
- Relevelling
- Hand pump
- Oil level indicator
- Oil heating
- Oil cooling
- Oil spillage tray
- Oil level switch
- Thermostat
- Hand Terminator
- Win delta 32 PC software



# RANGE OF DOORS



**M.S SWING DOOR**



**IMPERFORATED DOOR**

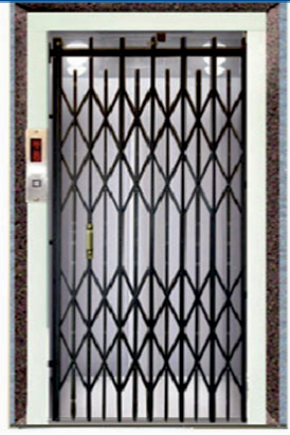

**COLLAPSIBLE DOOR**



**MANUAL TELESCOPIC DOOR**

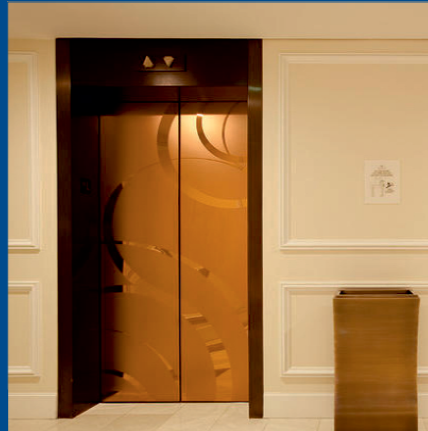

**S.S. DESIGN FINISH AUTO DOOR**



**M.S. AUTO DOOR**



**S.S. AUTO DOOR**



**S.S. HAIR LINE FINISH AUTO DOOR**



**S.S. FULL GLASS AUTO DOOR**



# RANGE OF CABIN

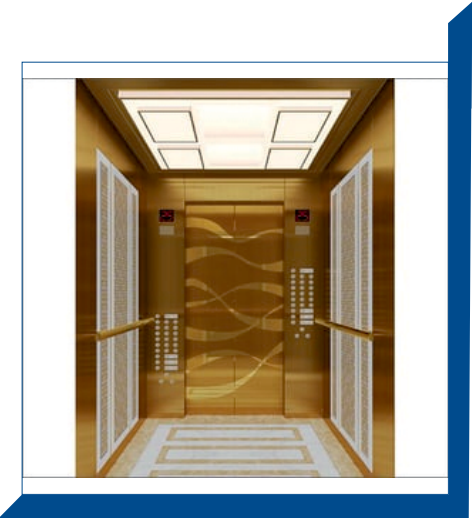
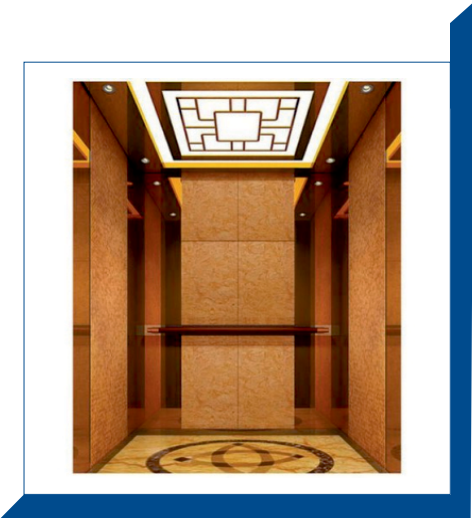
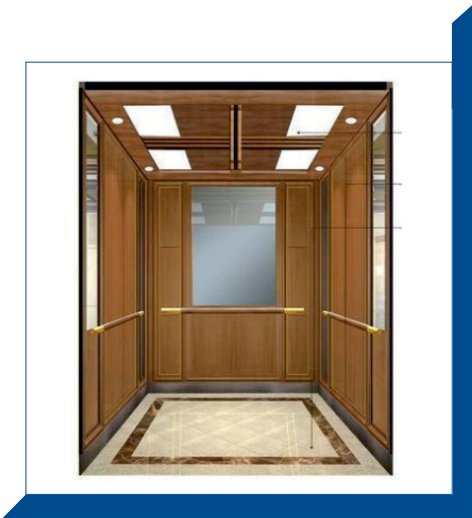
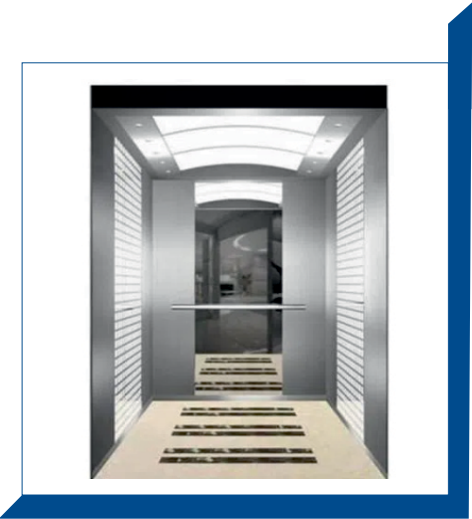
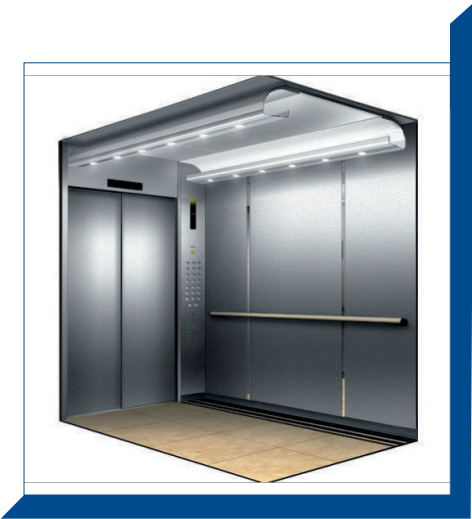
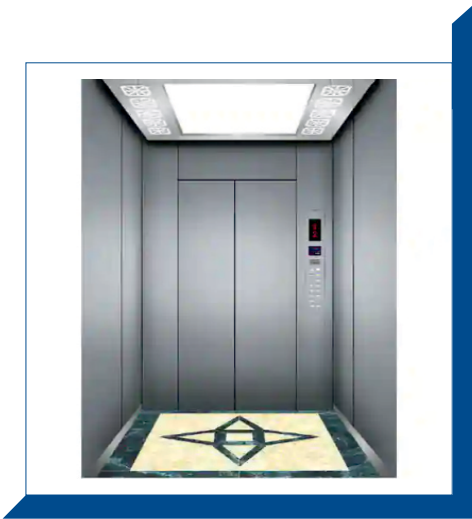
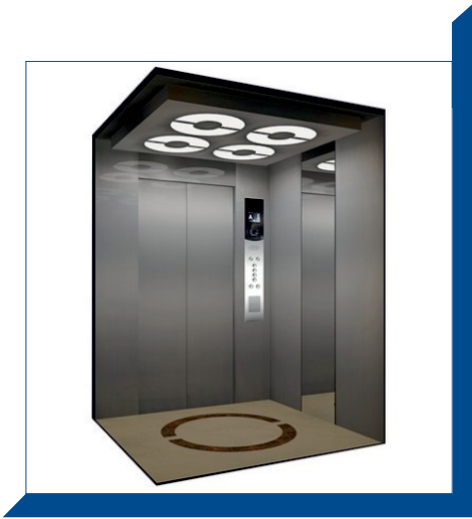

# OPERATING PANELS

## ■ FEATURES & SPECIFICATIONS

- Face Plates : Hairline finish S.S., Mirror finish S.S., Gold Mirror & Matt Finish S.S., Rose Finish S.S., & Black S.S.,
- Various push buttons of your choice.
- Position Indicator : 7 segments & arrow.
- Scrolling Dot Matrix display and LCD display e-motive display. Monochrome LCD, Multi color TFT Screen Display.



## DIAGNOSTIC CONTROLS

EXPRESS VVVF microprocessor based controller is designed to fulfill the customer's actual needs.

It uses latest electronics components and well-designed software having very low power consumption. It gives best level accuracy with very high response to the passenger call. It is provided with indication for quick and easy diagnosis.

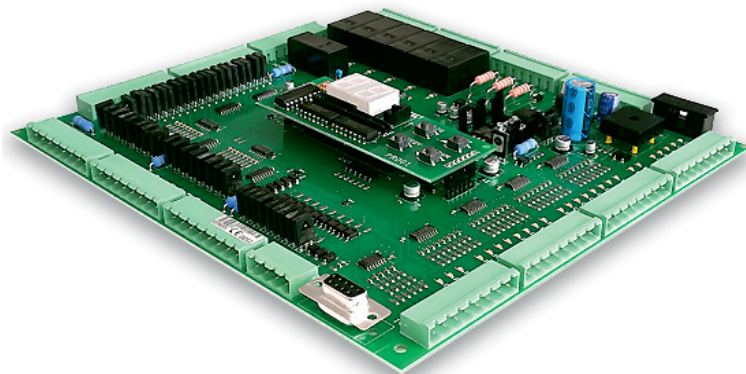



# MACHINES OVERVIEW

We manufacture six types of machines, they are bottom traction M/C. Single Traction M/C. Machine roomless. Gearless Permanent Magnet. Over speed governor with PMS motor.

Our machines are specially designed for various applications such as speed and capacity with rigid & rugged reliability, smooth trouble-free operation. We use standard worm and worm gears with taper roller bearings and thrust bearing in machine for maximum load-carrying capacity. The perfect lubrication system gives longer life and smooth operation. The machines are mounted on special types of rubbers which have extraordinary damping capacity, due to this characteristic, the machine runs vibration-free.



SINGLE SHAFT TRACTION M/C



SINGLE SHAFT TRACTION M/C



SINGLE SHAFT TRACTION M/C



MACHINE ROOMLESS



GEARLESS MACHINE



GREENSTAR



GEARLESS PERMANENT MAGNET



OVER SPEED GOVERNOR



OVER SPEED GOVERNOR



## ALERT PROMPT SERVICE

### We extend our service into your lift

The end of sales do not mean the end of our service. On the contrary, it is a new starting point of another kind of service. The after-sale service indicates the “social responsibility” consciousness and the creditable service attitude of an enterprise than mere product transaction. Our company provides you with 24 hour all weather service, at any time and place. In case of something is wrong with your lift, the company offers you the most professional solution in quickest speed and the shortest time possible. Our after sales engineers remain ever alert to attend your service call.

### The nation wide after-sale service network

Our company has set up many branches in many leading cities Enabling us to provide our local customers with the better response at the first time and prompt parts supply.

### 24 Hour emergency repair service

In case of any emergency Our company has specially set up 24 hour customer hotline. We will provide urgent paid service at the first moment.

### Service center

From building projects of customers to the life long services, Our company provides customer with meticulous services with keen consideration for all the procedures.

### Monitor Network

Our company regularly assigns the staff to detect your equipment’s travel conditions and provides most professional maintenance.

## MACHINE ROOMLESS ELEVATOR

The machine roomless elevators save construction space to a large extent. The permanent magnet synchronous motored gearless machines have unapproachable superiority to the traction motor and save roughly 35% of a compact design, light weight & operate quietly and there is no need for lubrication.

Such elevators have become more and more popular because they run at low noise are energy saving, eaving, easily maintainable and make the building look more aesthetically pleasing.

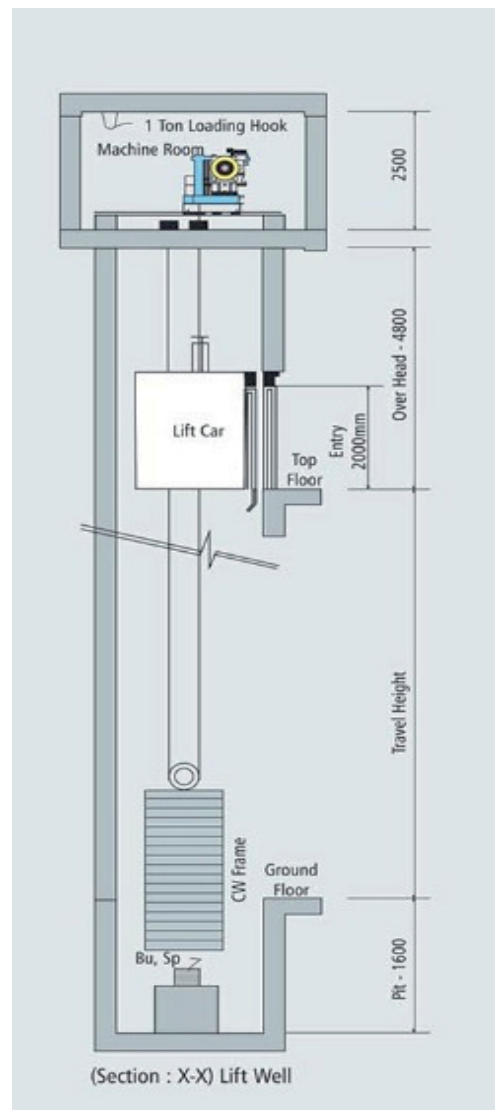
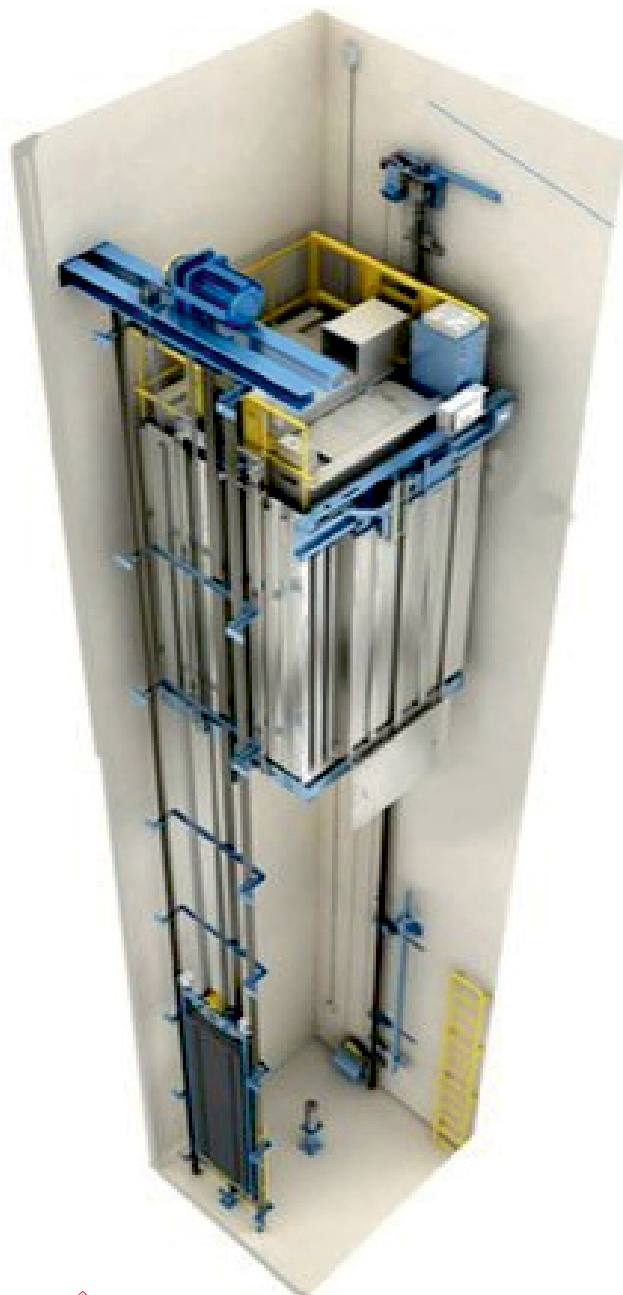

COLOR CHOICE

Elevate  
your  
life,  
Elevate  
your  
standards

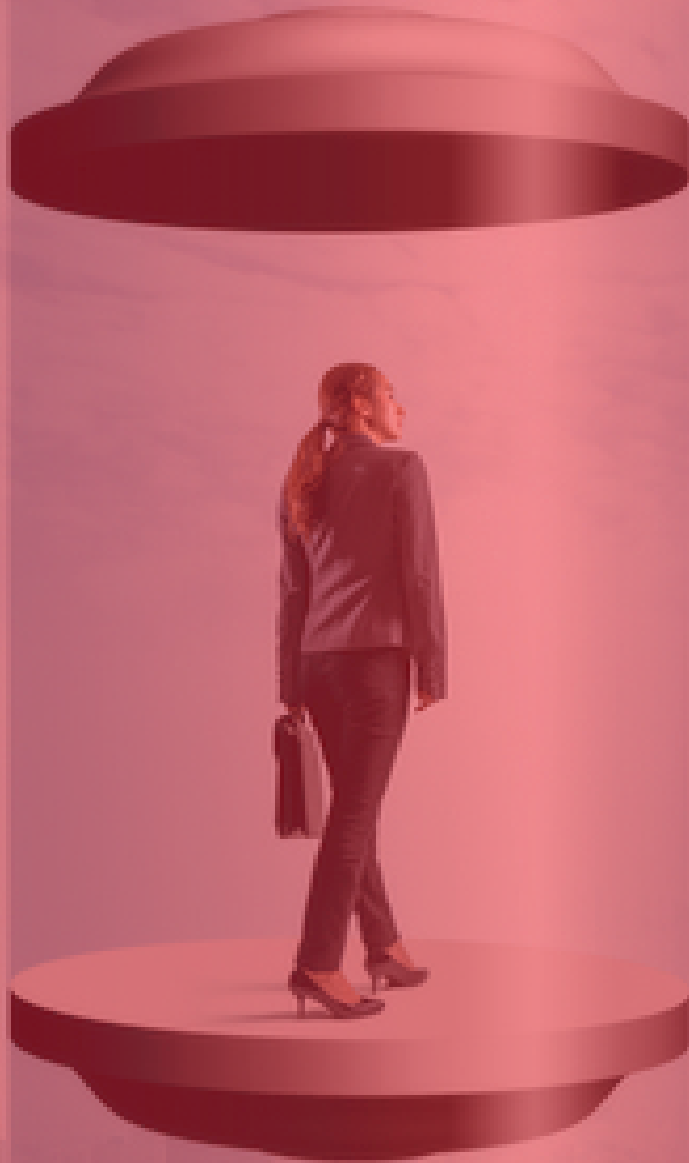



**Express**  
Elevator Company  
Solution Under One Roof

